	Kriss Motors Corporation 8345 NW 66th Street #8268 Miami, Florida 33166 <b>KrissMotors.com</b>	
	TITLE	CENTER PANEL    Barrier strips, other
DATE	06/30/15	

L panel/R out

Same color in/out unless indicated

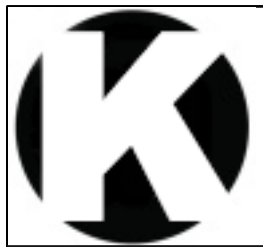
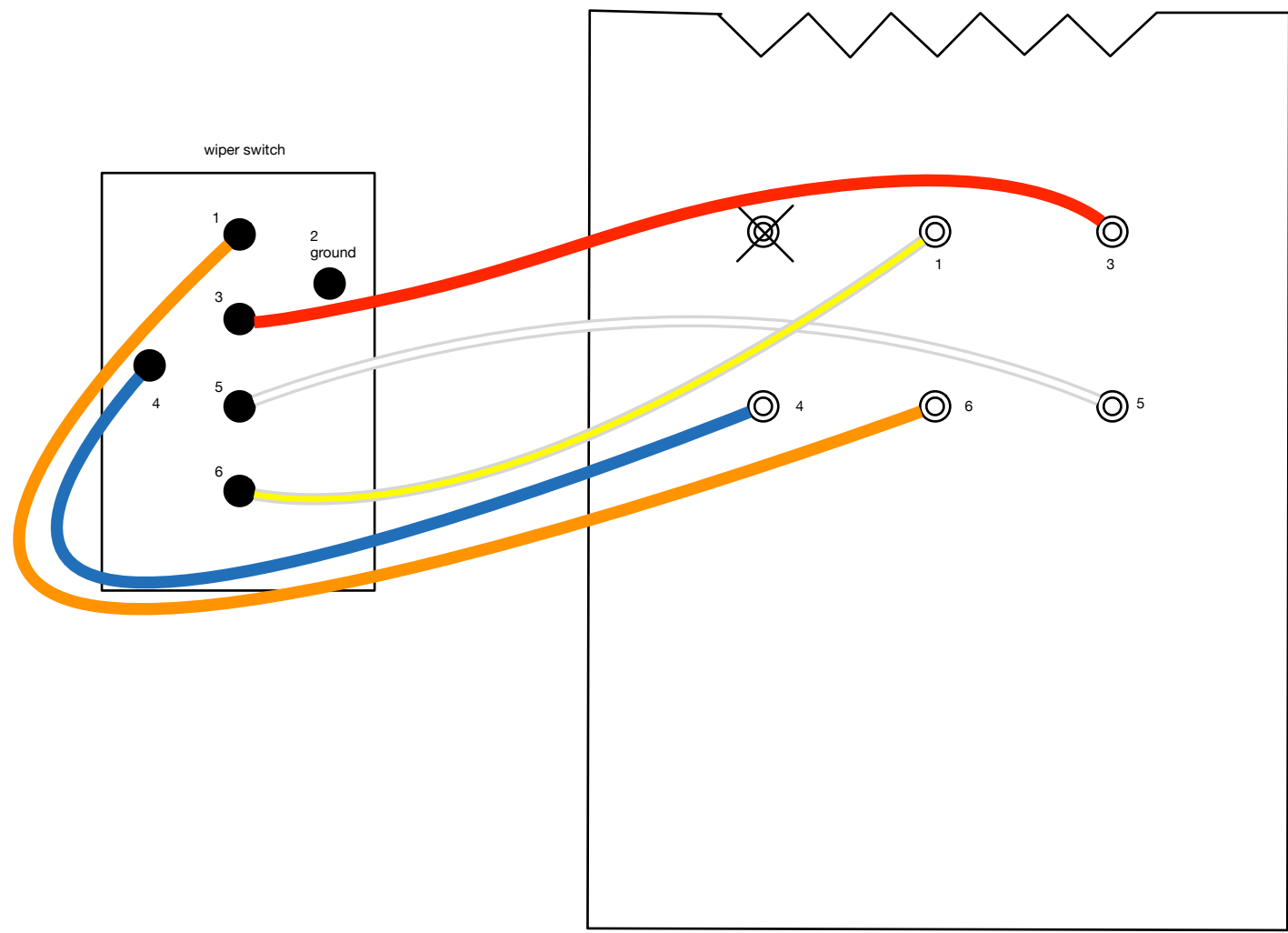

Kriss Motors Corporation  
8345 NW 66th Street #8268  
Miami, Florida 33166  
**KrissMotors.com**

TITLE CENTER PANEL CONNECTIONS Molex 6A

DATE 06/03/15

### L panel/R out

Same color in/out unless indicated

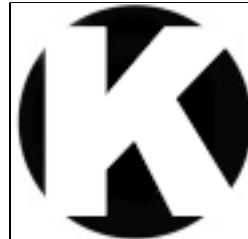
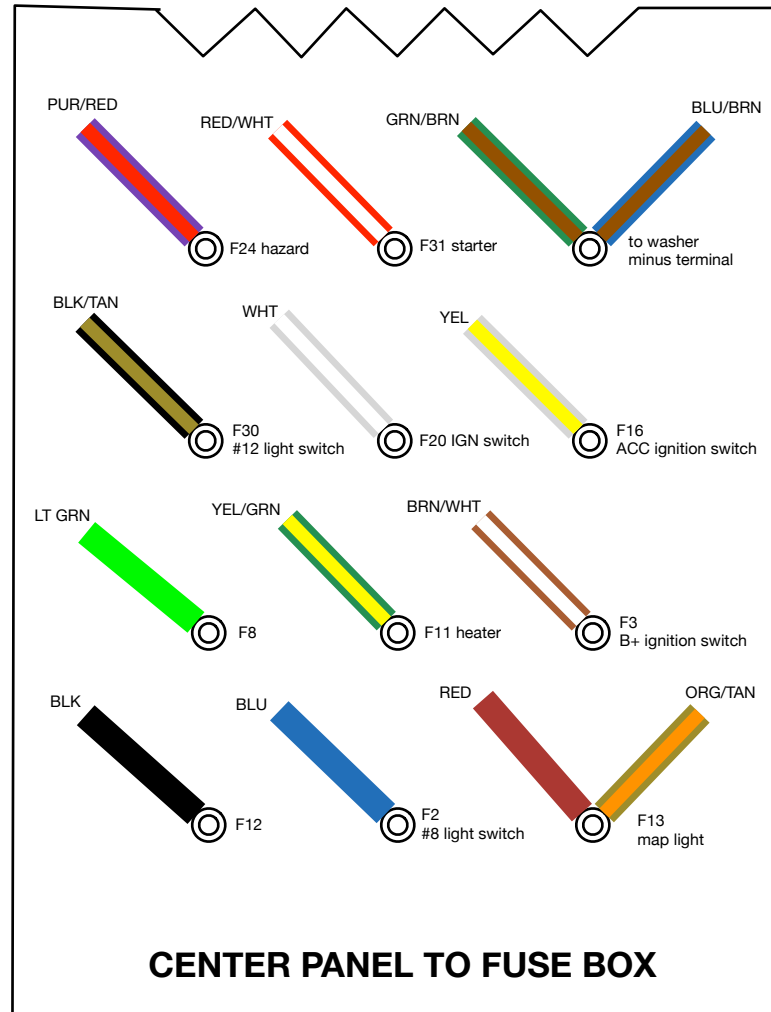

Kriss Motors Corporation  
8345 NW 66th Street #8268  
Miami, Florida 33166  
**KrissMotors.com**

TITLE CENTER PANEL CONNECTIONS Molex 12A

DATE 06/03/15

### L panel/R out

Same color in/out unless indicated

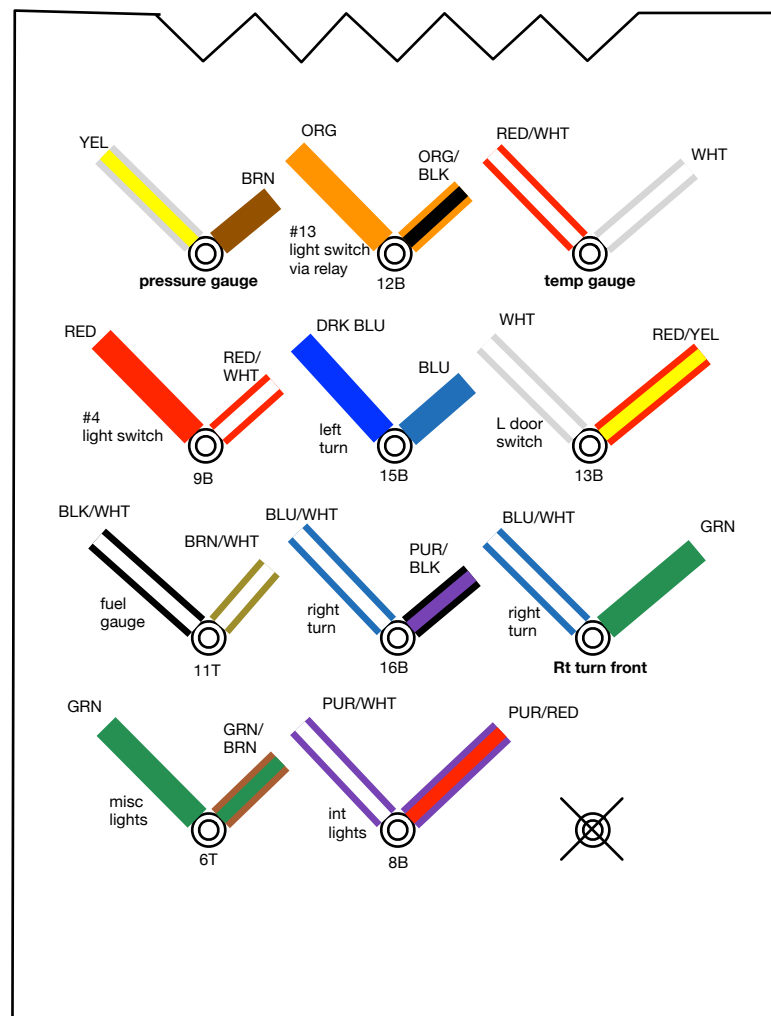

Kriss Motors Corporation  
 8345 NW 66th Street #8268  
 Miami, Florida 33166  
**KrissMotors.com**

TITLE CENTER PANEL CONNECTIONS Molex 12B

DATE 06/03/15

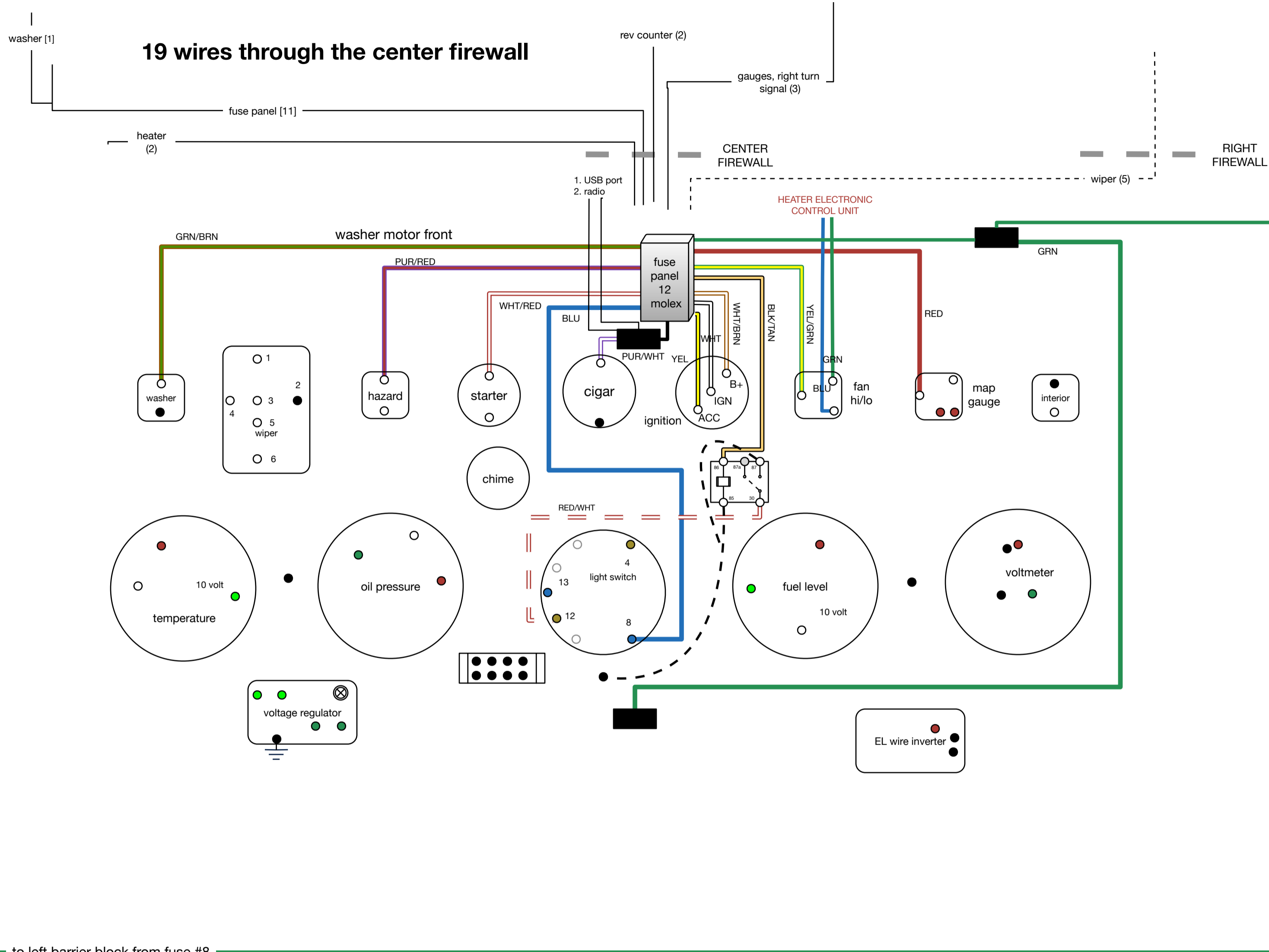

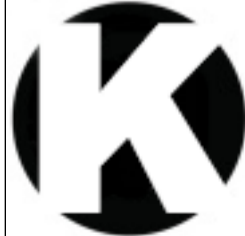
	Kriss Motors Corporation 8345 NW 66th Street #8268 Miami, Florida 33166 <b>KrissMotors.com</b>	
	TITLE	CENTER PANEL Fuse panel
DATE	07/28/15	

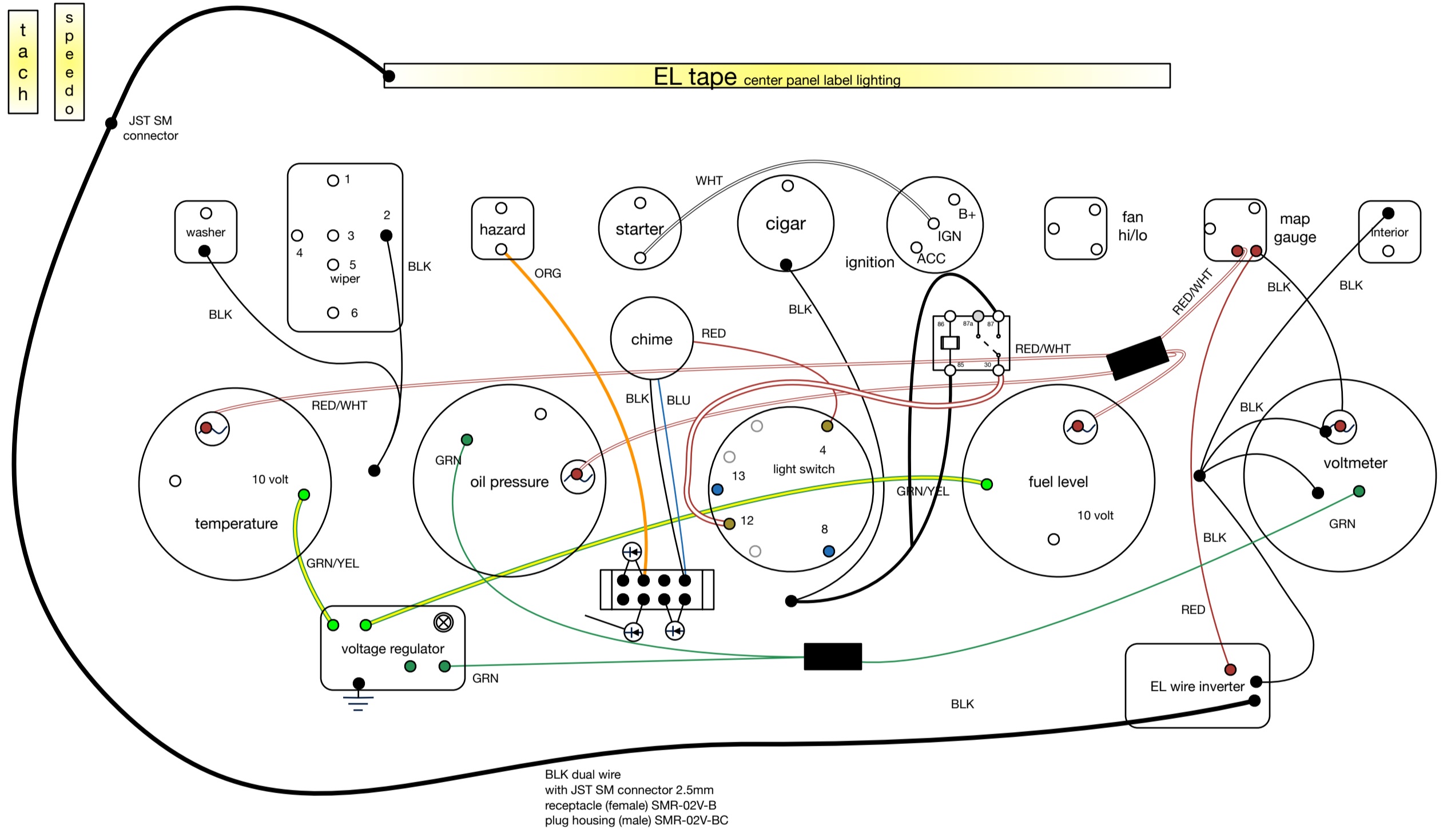

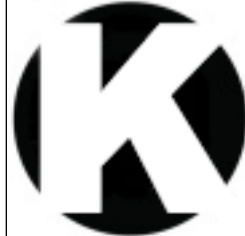
	Kriss Motors Corporation 8345 NW 66th Street #8268 Miami, Florida 33166 <b>KrissMotors.com</b>	
	TITLE	CENTER PANEL Internal wires
DATE	06/30/15	